

Per- and Polyfluoroalkyl Substances(PFAS) analysis in drinking water using anion exchange SPE - LC-MS/MS with Active Carbon Delay Column

	EPA 533	EPA537.1	ISO 21675	JP standard^{※1}
SPE Mode	Weak anion exchange	Reversed Phase	Weak anion exchange	Weak anion exchange
Sample flow rate	5 mL/min	10-15 mL/min	3-6 mL/min	5 mL/min

※Ministry of Health, Labour, and Welfare

Selecting SPE sorbent

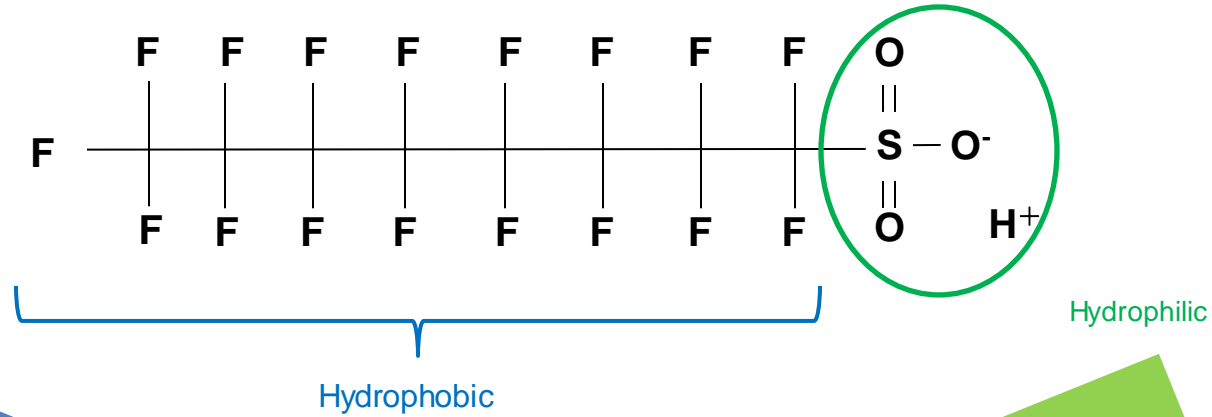

InertSep PLS-2



Styrene divinylbenzene polymer



InertSep MA-2



Weak anion exchange methacrylate polymer

SPE Procedure Reversed Phase

-EPA Method 537.1-

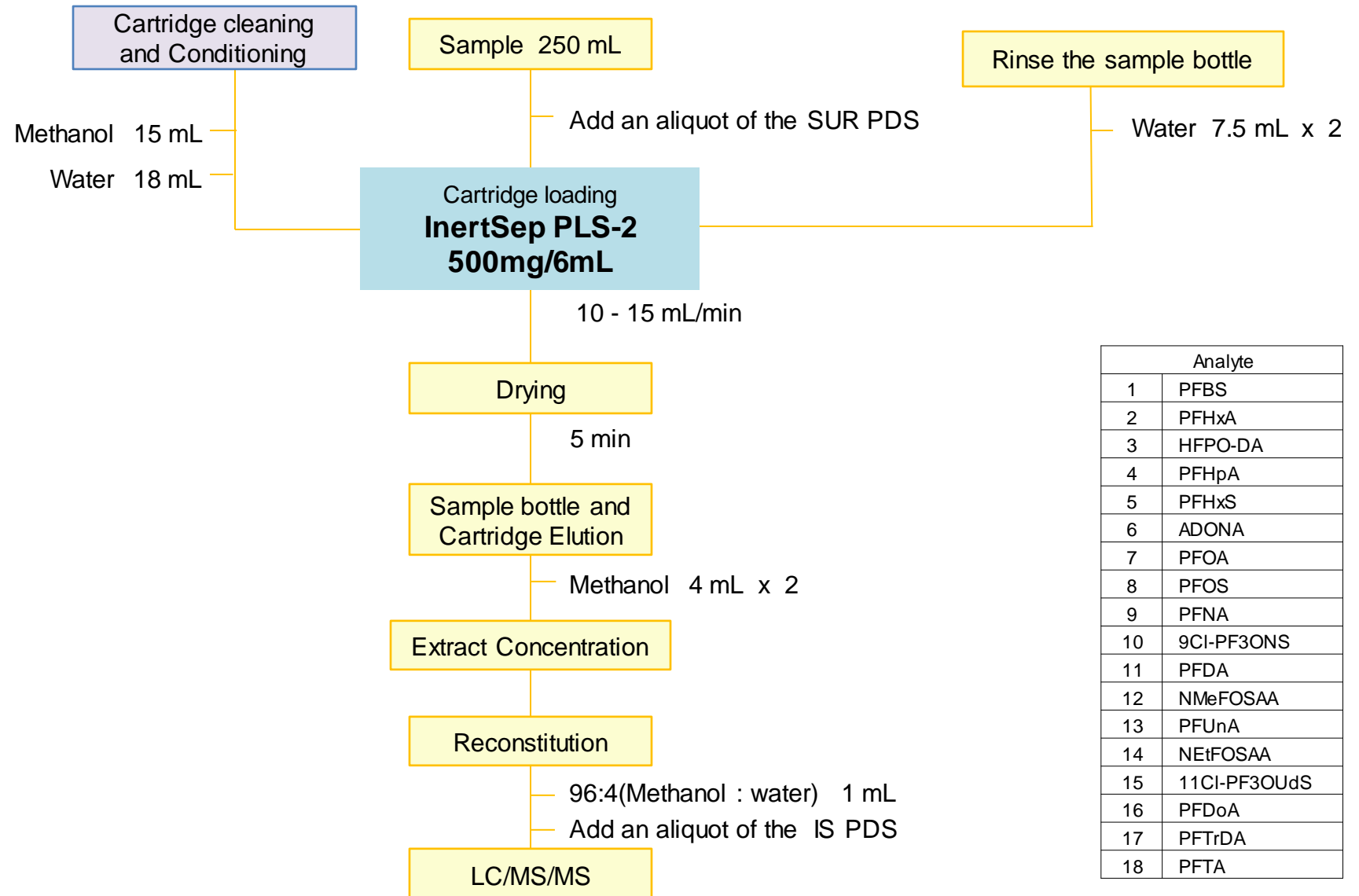

Analyte	
1	PFBS
2	PFHxA
3	HFPO-DA
4	PFHpA
5	PFHxS
6	ADONA
7	PFOA
8	PFOS
9	PFNA
10	9Cl-PF3ONS
11	PFDA
12	NMeFOSAA
13	PFUnA
14	NEtFOSAA
15	11Cl-PF3OUdS
16	PFDoA
17	PFTTrDA
18	PFTA

SPE Procedure Anion Exchange

-EPA Method 533-

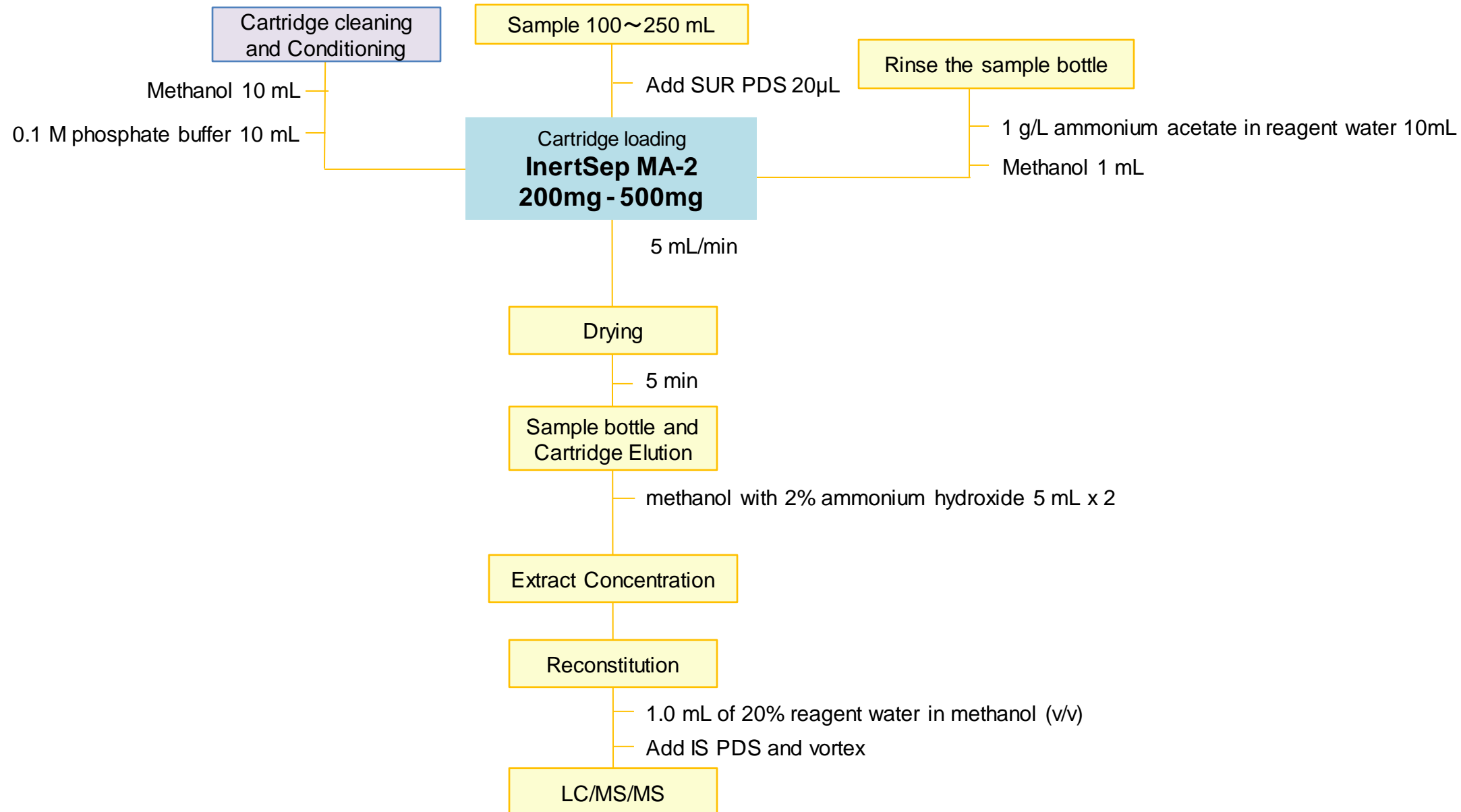

Ion Exchange -Japan standard Method-

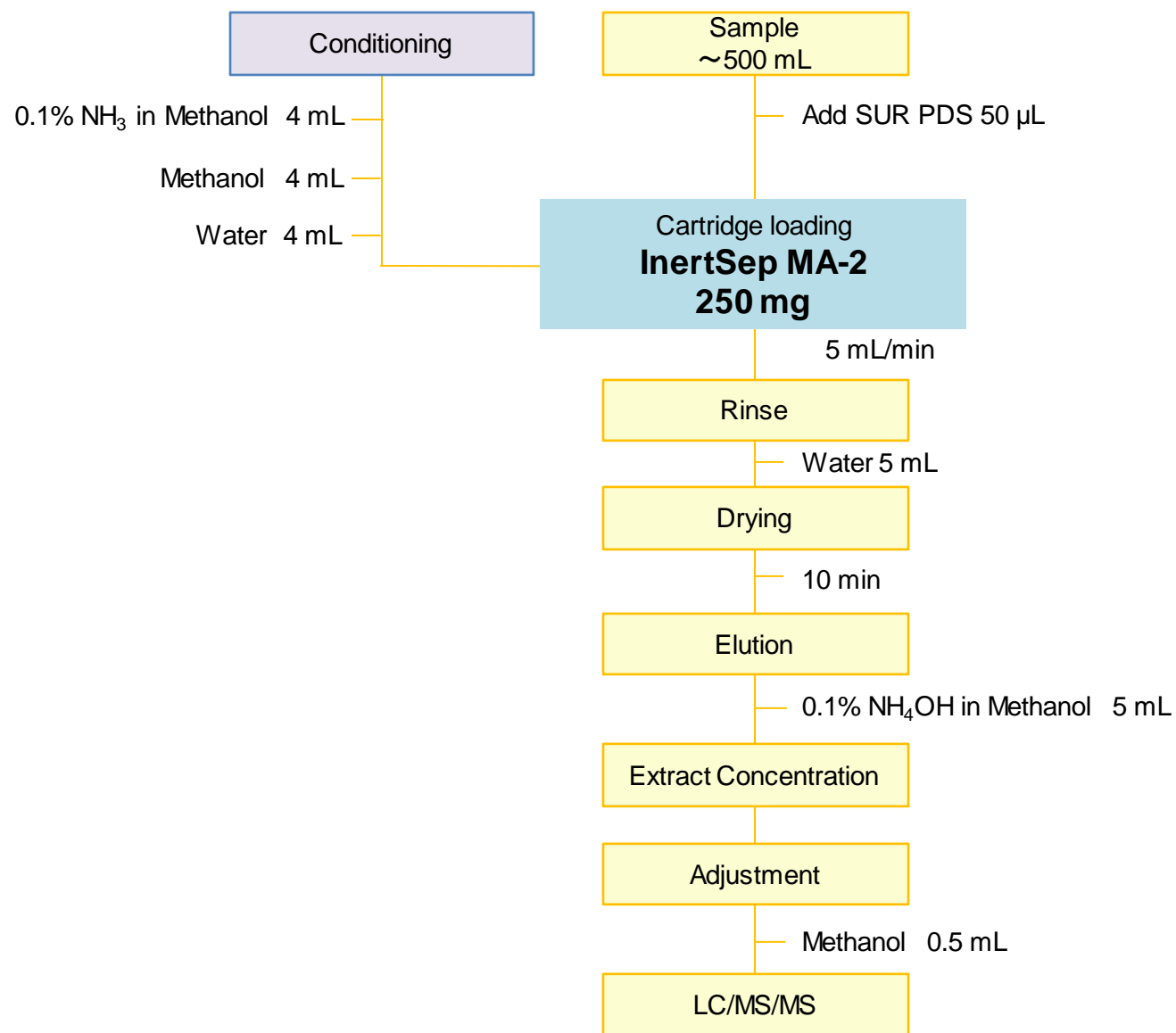

#	Compounds	1ng/L	1-50ng/L
		Recovery	Linear
1	PFBS	92%	0.9998
2	PFPeS	95%	0.9998
3	PFHxS	97%	0.9996
4	PFHpS	93%	0.9990
5	PFOS	102%	0.9995
6	PFNS	95%	0.9960
7	PFDS	86%	0.9992
8	PFDoS	83%	0.9990
9	PFBA	80%	0.9999
10	PFPeA	100%	0.9999
11	PFHxA	96%	0.9999
12	PFHpA	107%	0.9996
13	PFOA	99%	0.9999
14	PFNA	87%	0.9999
15	PFDA	101%	1.0000
16	PFUdA	104%	0.9997
17	PFDaA	96%	0.9999
18	PFTrDA	108%	0.9997
19	PFTeDA	88%	0.9999
20	PFHxDA	119%	0.9999
21	PFODA	99%	0.9990

※MA-2 280mg

SPE Elution Profile

Elution profile of the MA-2 SPE cartridge. The sample is water containing the PFAS 21, and the recovery rate is shown for each of 1 mL elution volume. Because the InertSep MA -2 is a pure ion exchange mode with no reverse-phase behavior, you can easily and effectively elute even high carbon PFAS, such as PFOxDA(C18), with a small amount of solvent.

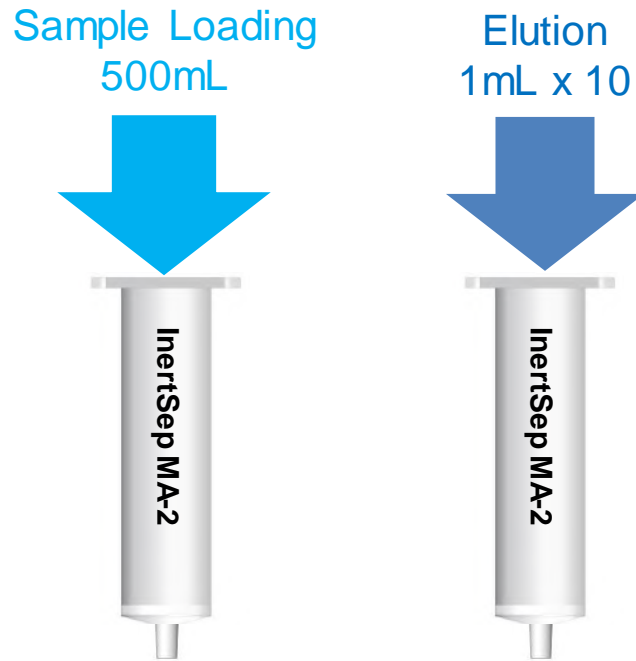

SPE Cartridge : InertSep MA-2 250mg
 Solvent : 0.1% ammonium methanol
 Elution Volume : 1mL x 10

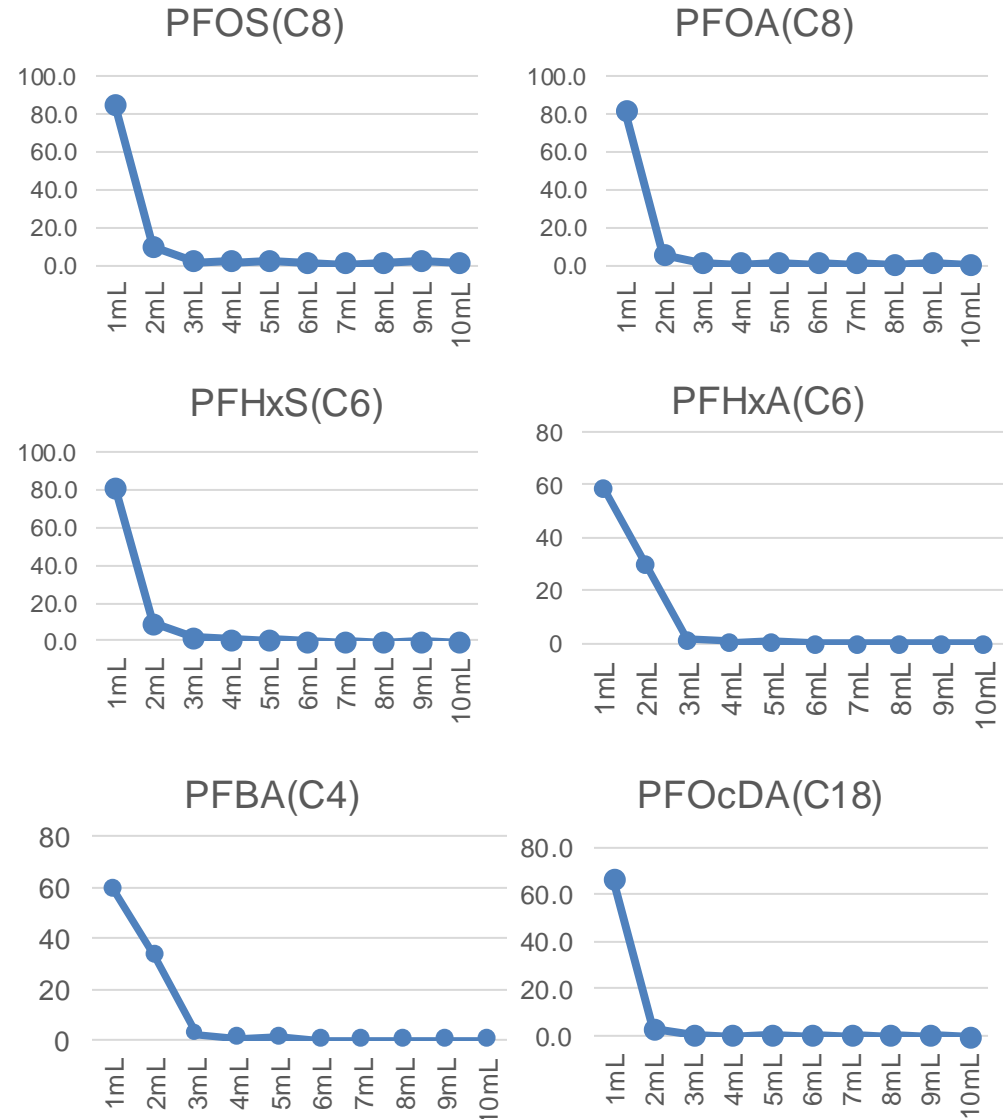

SPE procedure comparison

Depending on the sensitivity and performance of LC/MS, your SPE method can be simplified by, for example, reducing the enrichment factor. Evaporation of the elution solvent is an effective way to save time and prevent contamination during the experiment. You can also scale down the amount of sample water, the size of the SPE cartridge, and the amount of the elution solvent.

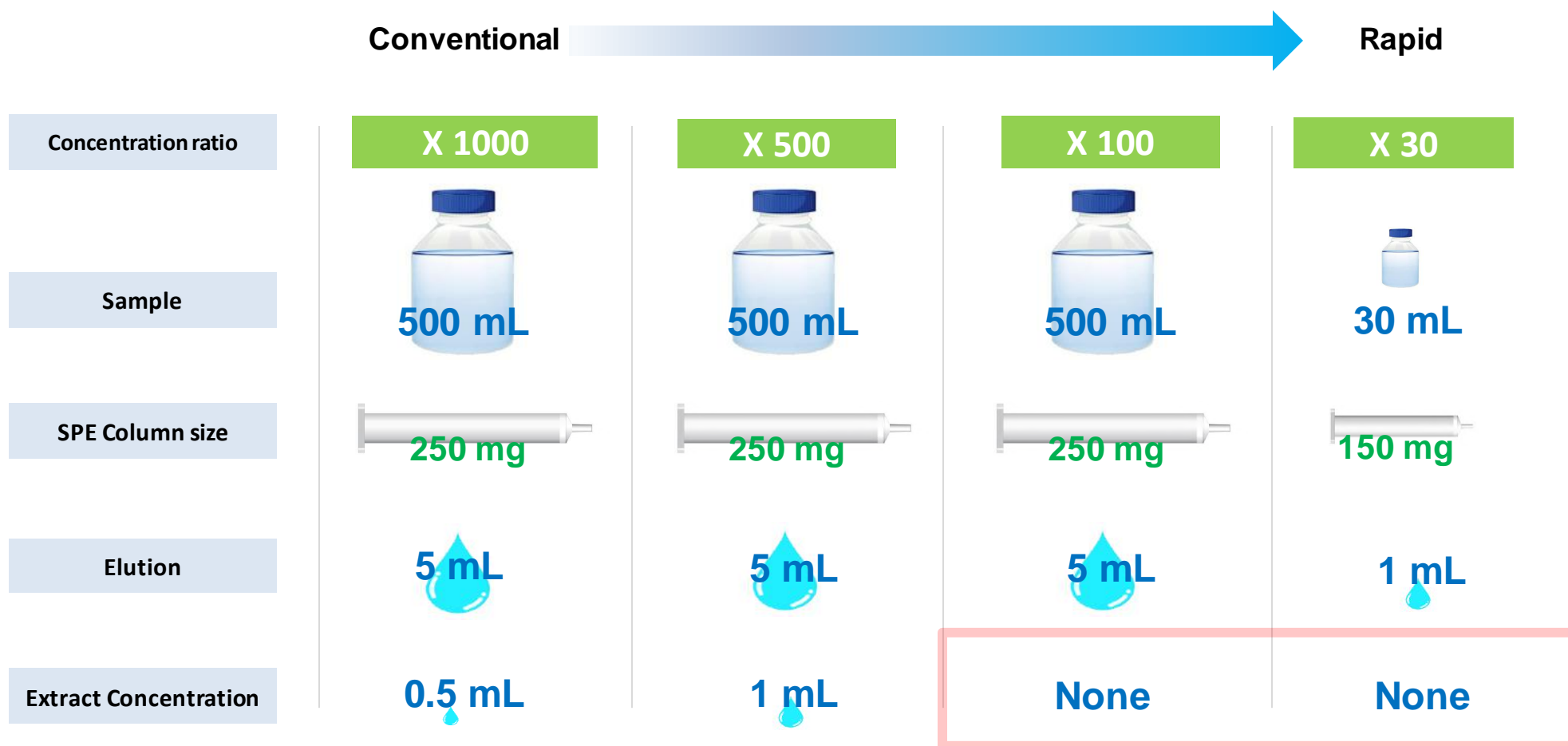

Rapid SPE Procedure

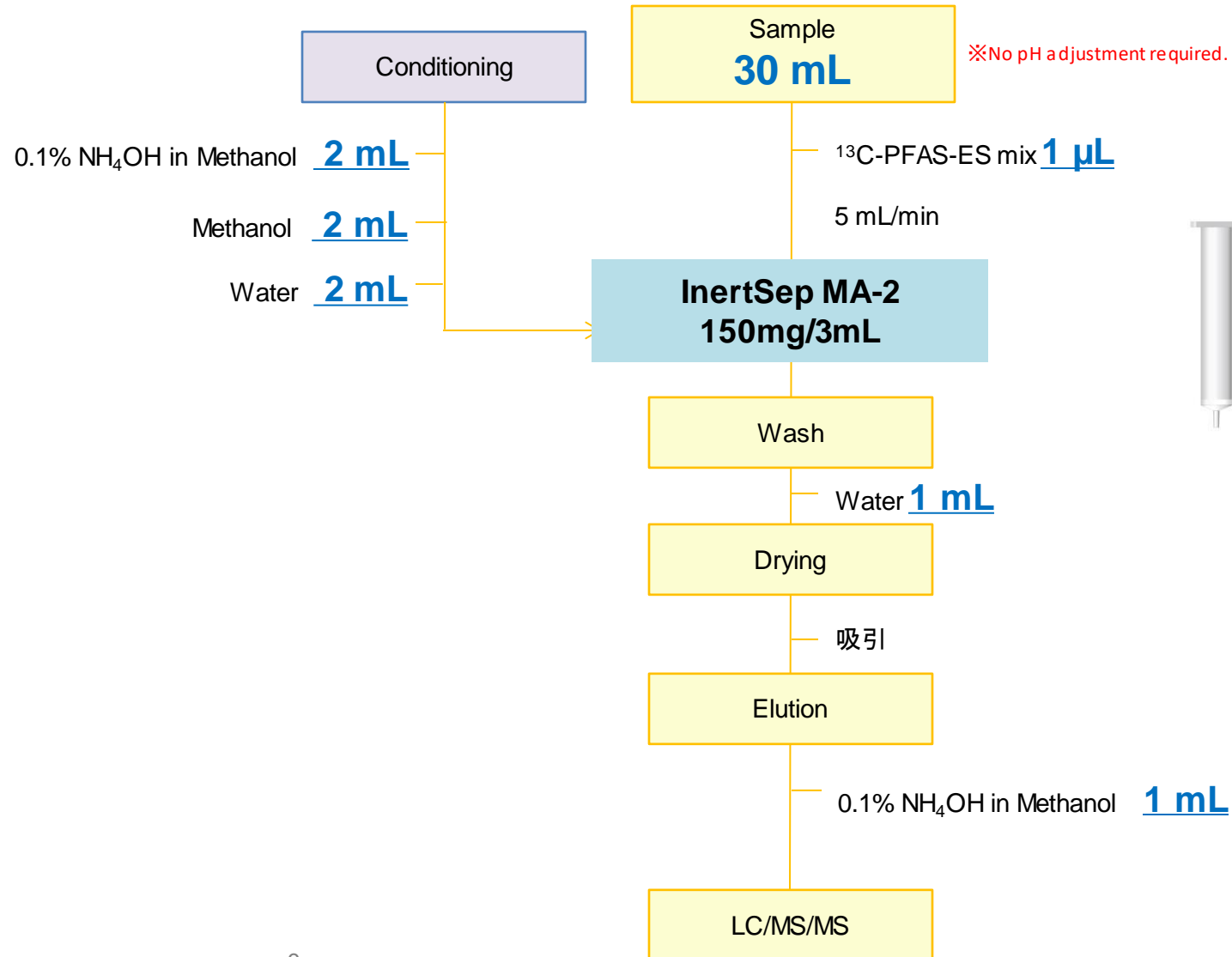

	Compounds	10ng/L (n=2)	
		Recovery(%)	CV(%)
1	PFBS	110	5.3
2	PFPeS	108	10.9
3	PFHxS	111	3.3
4	PFHpS	93	4.3
5	PFOS	103	0.2
6	PFNS	84	11.1
7	PFDS	92	25.9
8	PFDoS	75	5.2
9	PFBA	82	13.3
10	PFPeA	96	1.2
11	PFHxA	106	16.4
12	PFHpA	72	2.7
13	PFOA	89	4.4
14	PFNA	98	3.3
15	PFDA	95	1.0
16	PFOcDA	91	14.0
17	PFDODA	104	8.4
18	PFTTrDA	102	2.1
19	PFTeDA	107	6.2
20	PFHxDA	104	5.5
21	PFOcDA	114	7.6

LC-MS/MS Conditions

HPLC Condition

System	Nexera UHPLC System(Shimadzu)																					
Column	InertSustain C18 HP 3 µm, 2.1 x 150 mm Delay column for PFAS 3.0 x 30 mm																					
Elution	A)10 mM CH ₃ COONH ₄ in H ₂ O B)ACN																					
Gradient	<table border="1"><thead><tr><th>Time</th><th>A%</th><th>B%</th></tr></thead><tbody><tr><td>0.0</td><td>80</td><td>20</td></tr><tr><td>2.0</td><td>80</td><td>20</td></tr><tr><td>15.0</td><td>0</td><td>100</td></tr><tr><td>17.0</td><td>0</td><td>100</td></tr><tr><td>17.1</td><td>80</td><td>20</td></tr><tr><td>23.0</td><td>80</td><td>20</td></tr></tbody></table>	Time	A%	B%	0.0	80	20	2.0	80	20	15.0	0	100	17.0	0	100	17.1	80	20	23.0	80	20
Time	A%	B%																				
0.0	80	20																				
2.0	80	20																				
15.0	0	100																				
17.0	0	100																				
17.1	80	20																				
23.0	80	20																				
Flow rate	0.3 mL/min																					
Col. Temp.	40°C																					
Injection Vol.	1 µL																					

MS/MS Condition

System	4000 QTRAP(SCIEX)						
Mode	ESI, Negative, MRM						
CUR	CAD	IS	TEM	GS1	GS2	ihe	
20	12	-3700	400	30	30	on	

PFCAs

Compounds		Q1/Q3	DP	EP	CE	CXP
C4 Perfluorobutanoic acid	PFBA	213/169	-45	-10	-14	-9
C5 Perfluoropentanoic acid	PFPeA	263/219	-50	-10	-11	-9
C6 Perfluorohexanoic acid	PFHxA	313/269	-50	-10	-15	-9
C7 Perfluoroheptanoic acid	PFHpA	363/319	-55	-10	-14	-9
C8 Perfluorooctanoic acid	PFOA	413/369	-45	-10	-14	-9
C9 Perfluorononanoic acid	PFNA	463/419	-65	-10	-16	-9
C10 Perfluorodecanoic acid	PFDA	513/469	-65	-10	-14	-9
C11 Perfluoroundecanoic acid	PFUnDA	563/519	-65	-10	-16	-9
C12 Perfluorododecanoic acid	PFDoDA	613/569	-40	-10	-17	-9
C13 Perfluorotridecanoic acid	PFTTrDA	663/619	-50	-10	-19	-9
C14 Perfluorotetradecanoic acid	PFTeDA	713/669	-50	-10	-15	-9
C16 Perfluorohexadecanoic acid	PFHxDA	813/769	-65	-10	-17	-9
C18 Perfluorooctadecanoic acid	PFOcDA	913/869	-65	-10	-17	-12

PFASs

Compounds		Q1/Q3	DP	EP	CE	CXP
C4 Perfluorobutanesulfonic acid	PFBS	299/80	-80	-10	-62	-3
C5 Perfluoropentanesulfonic acid	PFPeS	349/80	-100	-10	-70	-13
C6 Perfluorohexanesulfonic acid	PFHxS	399/80	-80	-10	-80	-3
C7 Perfluoroheptanesulfonic acid	PFHpS	449/80	-100	-10	-104	-15
C8 Perfluorooctanesulfonic acid	PFOS	499/80	-90	-10	-95	-3
C9 Perfluoronanesulfonic acid	PFNS	549/80	-105	-10	-116	-13
C10 Perfluorodecanesulfonic acid	PFDS	599/80	-80	-10	-80	-3
C12 Perfluorododecanesulfonic acid	PFDoS	699/80	-115	-10	-126	-13

Extraction Standard

Compounds	Q1/Q3	DP	EP	CE	CXP
¹³ C ₄ -PFBA	217/172	-30	-10	-14	-31
¹³ C ₅ -PFPeA	268/223	-25	-10	-12	-11
¹³ C ₅ -PFHxA	318/273	-30	-10	-14	-47
¹³ C ₄ -PFHpA	367/322	-30	-10	-14	-19
¹³ C ₈ -PFOA	421/376	-30	-10	-14	-9
¹³ C ₉ -PFNA	472/427	-30	-10	-14	-11
¹³ C ⁶ -PFDA	519/474	-40	-10	-16	-13
¹³ C ₇ -PFUdA	570/525	-60	-10	-16	-7
¹³ C ₂ -PFDoA	615/570	-40	-10	-18	-15
¹³ C ₂ -PFTeDA	715/670	-45	-10	-18	-17
¹³ C ₃ -PFBS	302/80	-75	-10	-70	-13
¹³ C ₃ -PFHxS	402/80	-75	-10	-84	-13
¹³ C ₈ -PFOS	507/80	-110	-10	-90	-13

Injection Standard

Compounds	Q1/Q3	DP	EP	CE	CXP
¹³ C ³ -PFBA	216/172	-30	-10	-14	-19
¹³ C ₂ -PFOA	415/370	-30	-10	-14	-9
¹³ C ₂ -PFDA	515/470	-35	-10	-16	-35
¹³ C ₄ -PFOS	503/80	-105	-10	-120	-13

PFAS 21 chromatogram

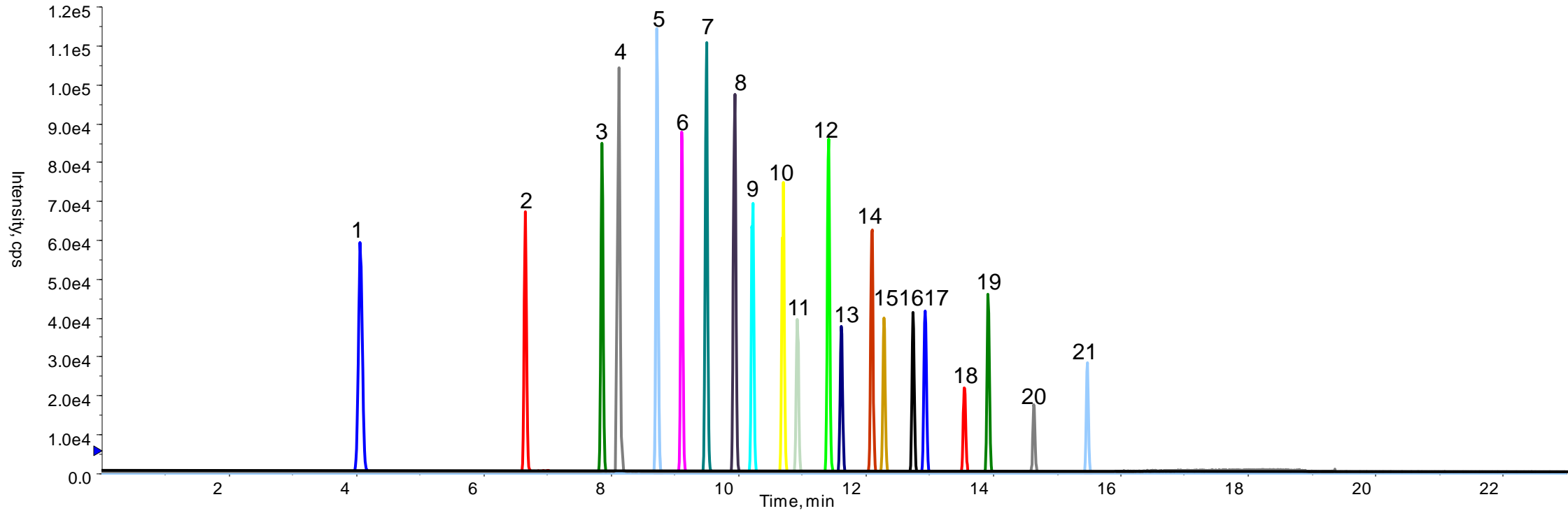

1. C4 Perfluorobutanoic acid	PFBA	8. C6 Perfluorohexanesulfonic acid	PFHxS	15. C12 Perfluorododecanoic acid	PFDoDA
2. C5 Perfluoropentanoic acid	PFPeA	9. C9 Perfluorononanoic acid	PFNA	16. C10 Perfluorodecanesulfonic acid	PFDS
3. C6 Perfluorohexanoic acid	PFHxA	10. C7 Perfluoroheptanesulfonic acid	PFHpS	17. C13 Perfluorotridecanoic acid	PFTTrDA
4. C4 Perfluorobutanesulfonic acid	PFBS	11. C10 Perfluorodecanoic acid	PFDA	18. C14 Perfluorotetradecanoic acid	PFTeDA
5. C7 Perfluoroheptanoic acid	PFHpA	12. C8 Perfluorooctanesulfonic acid	PFOS	19. C12 Perfluorododecanesulfonic acid	PFDoS
6. C5 Perfluoropentanesulfonic acid	PFPeS	13. C11 Perfluoroundecanoic acid	PFUnDA	20. C16 Perfluorohexadecanoic acid	PFHxDA
7. C8 Perfluorooctanoic acid	PFOA	14. C9 Perfluoronanonesulfonic acid	PFNS	21. C18 Perfluorooctadecanoic acid	PFOcDA

Delay Column for PFAS

- **Reduced LC-MS background**
- **Highly effective for PFAS Analysis**
- **Ultra high-purity activated carbon**
- **Low pressure**

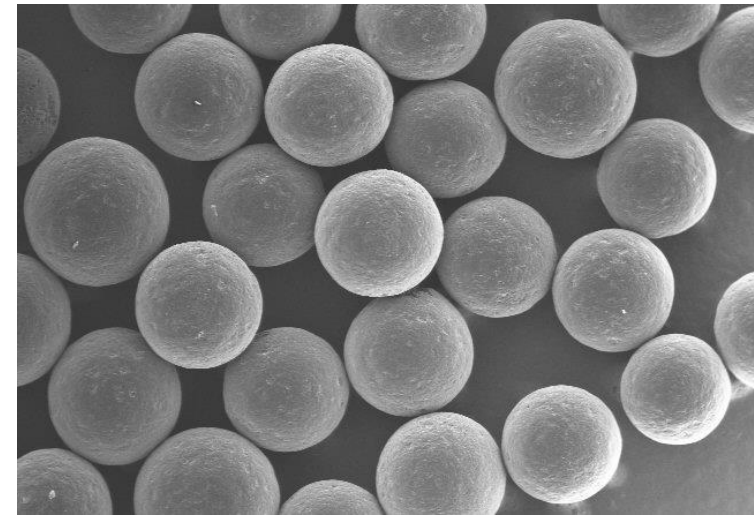

Delay Column for PFAS Installation position

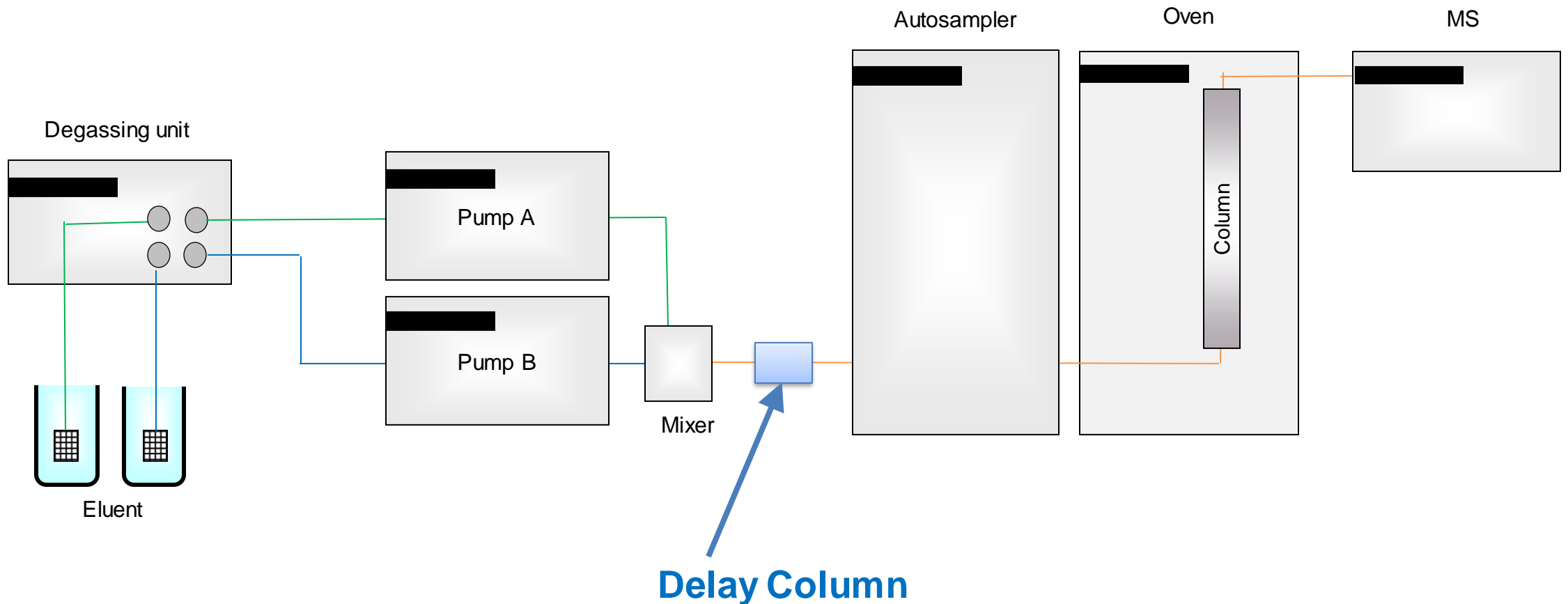

Chromatogram using Delay column for PFAS

The **Delay column for PFAS** is packed with high purity activated carbon beads, which strongly retain the background PFAS from the LC system and mobile phase. The retained PFAS compounds are eluted with 100% acetonitrile, allowing a greater separation from the analytes on the chromatogram.

Conditions

System : Nexera UFLC (Shimadzu) + 4000 QTRAP (SCIEX)

Column : InertSustain C18 (3 μ m HP, 150 x 2.1 mm I.D.)

Delay Column : Delay column for PFAS (30 x 3.0 mm I.D.)

Eluent : A) 10 mM Ammonium acetate
B) CH₃CN

Flow Rate : 0.3 mL/min

Oven Temp. : 40 °C

Injection : 1 μ L

Time	A%	B%
0.0	60	40
1.5	60	40
10.0	0	100
12.0	0	100
12.1	60	40
16.0	60	40

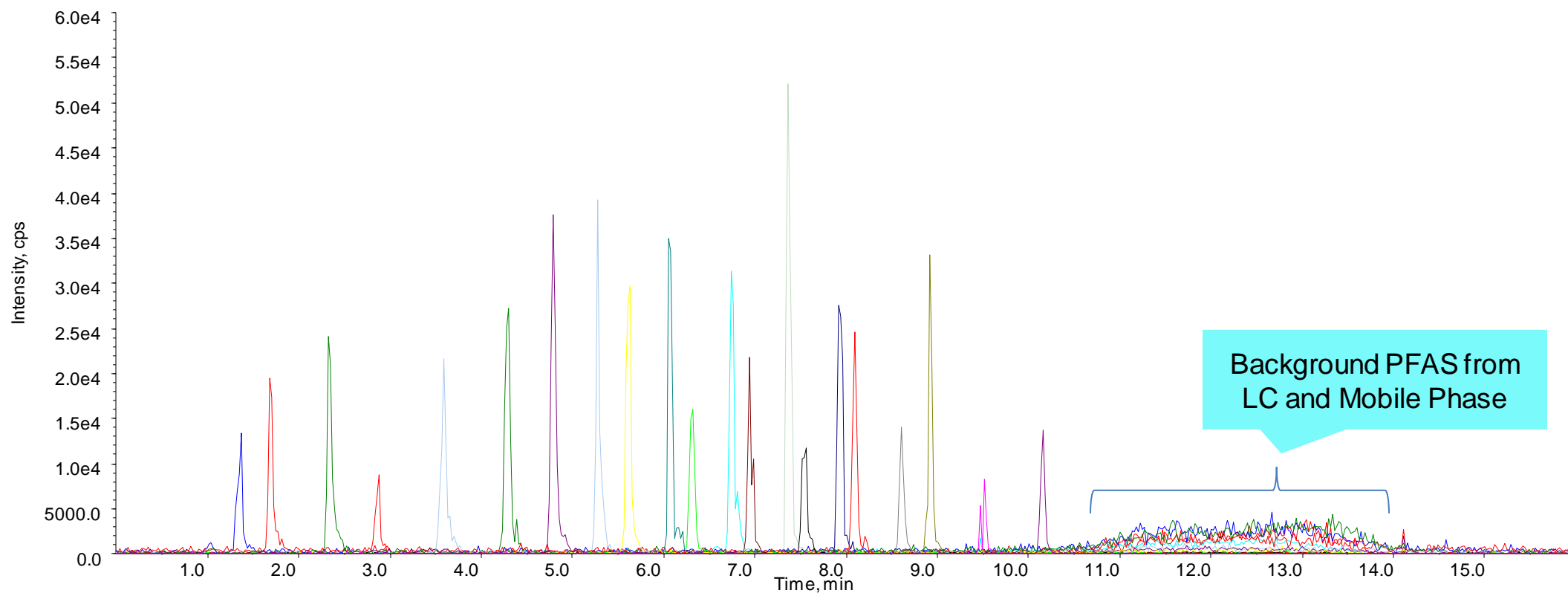

“Delay column for PFAS” effect

A comparison of the Delay column for PFAS with a general ODS column, which is commonly used as the Delay column. In contrast to the general ODS column that shows only a small delay and insufficient isolation, the Delay column for PFAS offers a better separation.

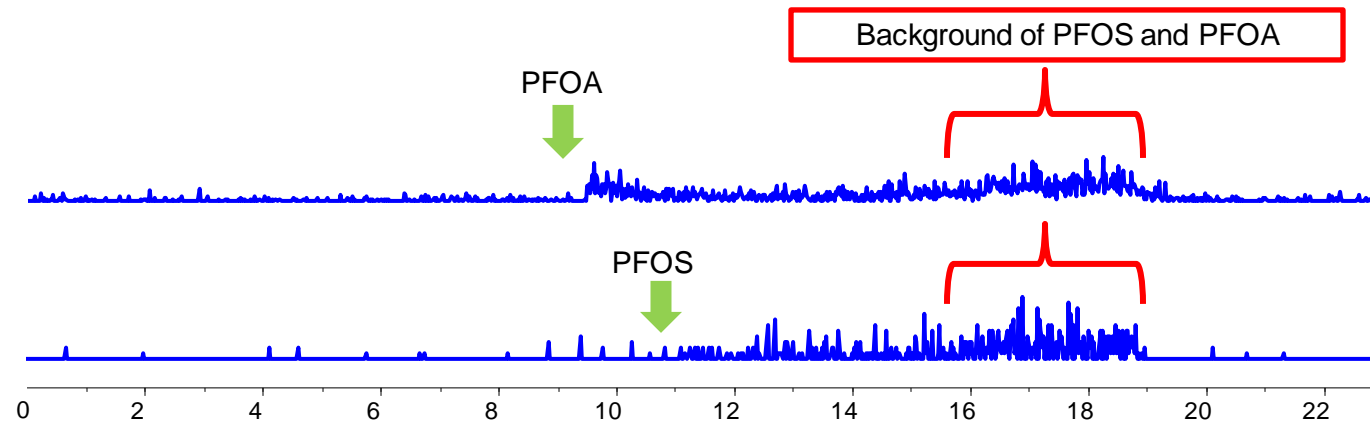

Delay
Column
For PFAS

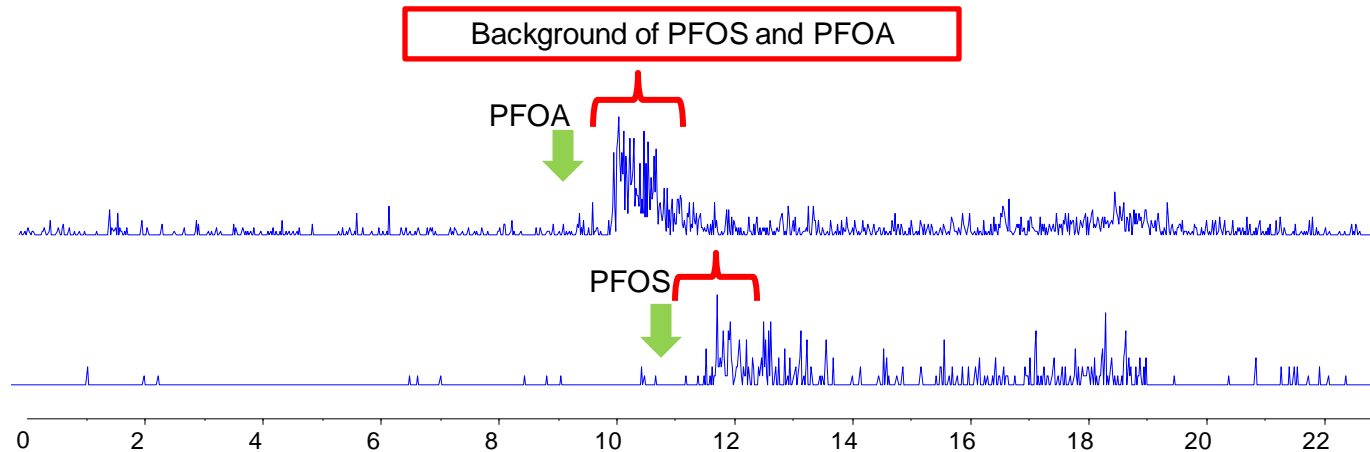

General ODS
column



Pressure comparison

Delay Column 	Analytical Column 	System Pressure
None	InertSustain C18 (2.1 x 150 mm 3 µm-HP)	19.8 MPa
Delay Column for PFAS (3.0 x 30 mm)		19.8 MPa
General ODS column (2.1 x 50 mm 3 µm)		23 MPa

※System: LC(Nexera, Shimadzu), MS/MS(4000 QTRAP, SCIEX)

Delay Column for PFAS does not increase the LC system pressure

SPE Cartridge Weak anion Exchange



InertSep MA-2

(Weak Anion Exchange)

Methacrylate polymer with Diethyl amine

Average Particle Size : 70 μm

Ion Capacity Volume : 0.5 meq/g

pH Range : 1 - 14

Remark : Cl⁻ Ion Pair

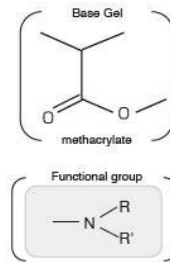

Description	Column Dimension	Qty.	Cat.No.
InertSep MA-2	30mg/1mL	100pcs	5010-27324
	60mg/3mL	100pcs	5010-27325
	100mg/3mL	50pcs	5010-27320
	150mg/3mL	50pcs	5010-27319
	250mg/6mL	30pcs	5010-27321
	500mg/6mL	30pcs	5010-27322
	1g/20mL	20pcs	5010-27326
	2g/20mL	20pcs	5010-27327

InertSep WAX

(Mix of Weak Anion Exchange and Reversed Phase)

SDB polymer with Diethyl amine

Average Particle Size : 70 μm

pH Range : 1 - 14

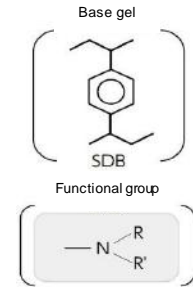

Description	Column Dimension	Qty.	Cat.No.
InertSep WAX FF	60mg/3mL	100pcs	5010-62760
	150mg/6mL	50pcs	5010-62761
	500mg/6mL	50pcs	5010-62762
	150mg/12mL	30pcs	5010-62763
	500mg/20mL	30pcs	5010-62764

SPE Cartridge Reversed Phase



InertSep PLS-2

Styrene-Divinylbenzene(SDB)copolymer
 Average Particle Size : 70 μm
 pH Range : 1 - 14

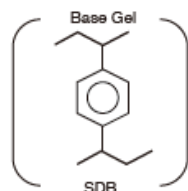

Description	Column Dimension	Qty.	Cat.No.
InertSep PLS-2	265mg/6mL	50pcs	5010-27430
	270mg/6mL	50pcs	5010-25020
	500mg/6mL	30pcs	5010-25025
	1000mg/6mL	20pcs	5010-25030
	265mg/20mL	20pcs	5010-27431
	270mg/20mL	20pcs	5010-25035
	500mg/20mL	20pcs	5010-25036
InertSep Slim-J PLS-2 (luer compatible)	230mg	50pcs	5010-65720
	265mg	50pcs	5010-65721

InertSep HLB

SDB and a nitrogen-containing vinyl monomer
 Average Particle Size : 60 μm , 30 μm
 Surface Area : 720 m^2/g
 pH Range : 1 - 14

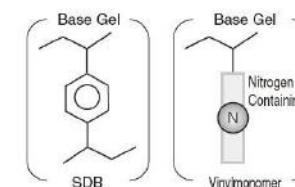

Description	Column Dimension	Qty.	Cat.No.
InertSep HLB FF 60 μm	60mg/3mL	50pcs	5010-27532
	200mg/6mL	30pcs	5010-27533
	500mg/6mL	30pcs	5010-27534
	200mg/20mL	20pcs	5010-27535
	500mg/20mL	20pcs	5010-27536
InertSep HLB 30 μm	10mg/1mL	100pcs	5010-27520
	30mg/1mL	100pcs	5010-27521
	60mg/3mL	50pcs	5010-27522
	200mg/6mL	30pcs	5010-27523
	500mg/6mL	30pcs	5010-27524

LC Column

InertSustain C18

Base Material: High Purity ES Silica Gel
 Surface Area: 350 m²/g
 Pore Size: 100 Å (10 nm)
 Pore Volume: 0.85 mL/g

Functional Group: Octadecyl
 End-capping: Yes
 Carbon Loading: 14.0 %
 pH Range: 1 - 10

Particle Size	I.D.	Length	Qty.	Cat.No.
3µm HP	2.1mm	50mm	1pc	5020-14412
3µm HP	2.1mm	100mm	1pc	5020-14414
3µm HP	2.1mm	150mm	1pc	5020-14415

InertSustain AQ-C18

Base Material : High Purity ES Silica Gel
 Surface Area: 350 m²/g
 Pore Size: 100 Å (10 nm)
 Pore Volume: 0.85 mL/g

Functional Group: Octadecyl
 End-capping: Yes
 Carbon Loading: 13.0 %
 pH Range: 1 - 10

Particle Size	I.D.	Length	Qty.	Cat.No.
1.9µm	2.1mm	100mm	1pc	5020-89939
1.9µm	2.1mm	150mm	1pc	5020-89940
3µm HP	2.1mm	150mm	1pc	5020-89924



Delay Column for PFAS

Particle	I.D.	Length	Qty.	Cat.No.
Active carbon	3.0mm	30mm	1pc	5020-90005

NORTH & LATIN AMERICA

GL Sciences Inc. USA

4733 Torrance Blvd. Suite 255

Torrance, CA 90503, USA

Tel : +1 310-265-4424

Fax : +1 310-265-4425

Email : info@glsciencesinc.com

Web : www.glsciencesinc.com

EUROPE

GL Sciences B.V.

Dillenburgstraat 7C

5652 AM Eindhoven The Netherlands

Tel : +31 (0)40 254 95 31

Email : info@glsciences.eu

Web : www.glsciences.eu

CHINA

GL Sciences (ShangHai) Ltd.

Tower B, Room 2003, Far East

International Plaza, NO,317 Xianxia

Road, Changning District. Shanghai,

China P.C. 200051

Tel : +86 (0)21-6278-2272

Email : contact@glsciences.com.cn

Web : www.glsciences.com.cn

HEAD QUARTER(JAPAN)

GL Sciences Inc.

22-1 Nishishinjuku 6-chome, Shinjuku-ku

Tokyo 163-1130, Japan

Tel : +81-(0)3-5323-6620

E-mail : world@gls.co.jp

Web : www.glsciences.com

International Distributors

www.glsciences.com/company/distributor.html